

Data Sheet



Article number: 432000400

Description: Rota-fix shaft-hub connection A 400x495
Steel

Note: Not self centering. Medium-high torques.

Measures

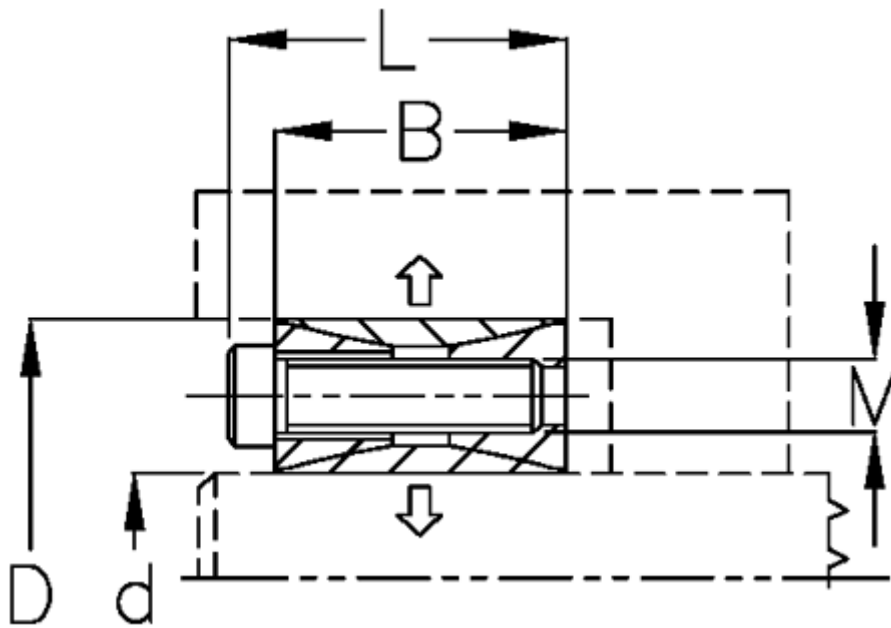

B mm	= 90
d H8 mm	= 400495
D mm	= 495
Fit tolerance	= Aksel k11-h11, Nav N11-H11
F kN torque	= 1845.0
L mm	= 112
M mm	= M22
P N/mm ² surface pressure on shaft/hub	= 118

Surface roughness	=
T N m torque	=
Ts N m bolt tightening torque	=